

wineo

THAT'S FLOORING

ZUBEHÖR | ACCESSORIES
ACCESSOIRES | ACCESORIOS

INHALT

CONTENT | CONTENU | CONTENIDO

Fußleisten Skirting boards Plinthes Zócalos	05
Unterlagsmaterial Underlay material Sous-couche Material base	22
Akzentstreifen Feature strips Joints effet carrelage Franjas decorativas	31
Hochzüge, Außenecken & Schmelzdrähte Skirting boards, external corners & weld rods Remontées, angles extérieurs & Cordons de soudures Rodapiés, esquinas exteriores & cordones des soldadura	32
Aluminiumprofile in Holz- und Metalloptik Aluminium Profiles in wood and metal finish Profilés aluminium aspect bois et métal Perfiles de aluminio en optica de maderay y métal	36
Verlegeutensilien & Reparaturartikel Installation tools & repair products Ustensiles de pose & articles de réparation Utensilios de instalación y artículos de reparación	42

SYSTEMATIK

SYSTEM | SYSTÉMATIQUE | SISTEMÁTICA

Grün steht für wineo PURLINE Bioboden; Zubehör, dass grün gekennzeichnet ist, passt zu wineo PURLINE Bioboden
Green symbolizes wineo PURLINE Organic Flooring; Accessoires which are marked in green are suitable for wineo PURLINE Organique Flooring | Vert es la couleur de wineo PURLINE Sol Organique; les accessoires qui sont marquer en vert vont bien avec les produits de wineo PURLINE Sol Organique | Verde es el color de wineo PURLINE Suelo Bio; los accesorios que están junto al color verde pertenecen a wineo PURLINE Suelo Bio

Pink steht für wineo Designboden; Zubehör, dass pink gekennzeichnet ist, passt zu wineo Designboden
Pink symbolizes wineo Design Flooring; Accessoires which are marked in pink are suitable for wineo Design Flooring
Pink est la couleur de wineo Sol Design; les accessoires qui sont marquer en vert vont bien avec les produits de wineo Sol Design | Pink es el color de wineo Suelo de Diseño; los accesorios que están junto al color verde pertenecen a wineo Suelo de Diseño

Türkis steht für wineo Laminatboden; Zubehör, dass türkis gekennzeichnet ist, passt zu wineo Laminatboden
Turquoise symbolizes wineo Laminate Flooring; Accessoires which are marked in turquoise are suitable for wineo Laminate Flooring | Turquoise est la couleur de wineo Sol Stratifié; les accessoires qui sont marquer en turquoise vont bien avec les produits de wineo Sol Stratéfie | Turquesa es el color de wineo Suelo Laminado; los accesorios que están junto al color turquesa pertenecen a wineo Suelo Laminado

Grau markiertes Zubehör passt zu allen wineo Produkten
Accessoires which are marked in grey are suitable for all wineo products | Accessoires qui sont marquer en gris sont adaptable avec tous les produits de wineo | Accesorios que están junto al color gris pertenecen a todos productos de wineo



FUSSLEISTEN

SKIRTING BOARDS | PLINTHES | ZÓCALOS



Art. 18,5/38,5 | MDF-Material
18,5 × 38,5 × 2400 mm | Box = 4 ×



14,5/50 | Plastic-Material
14,5 × 50 × 2400 mm | Box = 4 ×

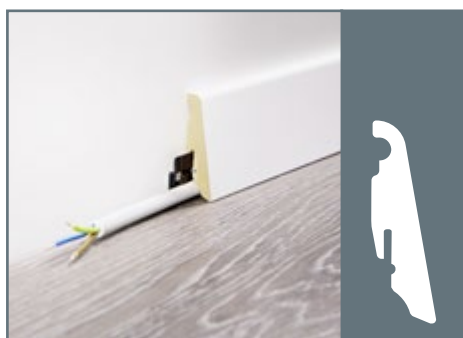

19/58 | MDF-Material
19 × 58 × 2400 mm | Box = 4 ×



15/70 | MDF-Material
15 × 70 × 2400 mm | Box = 4 ×



15/80 | MDF-Träger
15 × 80 × 2400 mm | Box = 4 ×

Clipholder-Befestigungssystem

Clipholder fastening system
 Système de fixation Clipholder
 Sistema de fijación Clipholder

Art. no. 30020241

Box = 30 Clips/
 ca. 15 lfm. | rm | metros lineales | ml



anzeichnen
 mark out
 maquage
 marcar

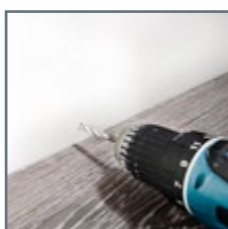

bohren
 drill
 perçage
 taladrar

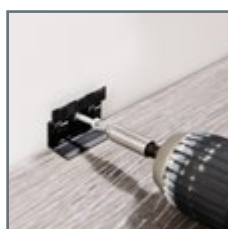

anschrauben
 screw on
 vissage
 atornillar

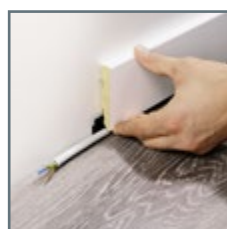















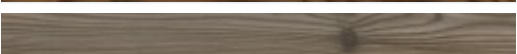











aufstecken
 put in place
 pose
 colocar

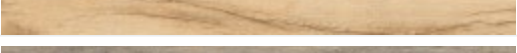

fertig
 done
 c est terminé
 listo

FUSSLEISTEN

SKIRTING BOARDS | PLINTHES | ZÓCALOS

Design	fit to article	
Acadia	PLEW10006	
Arctic Oak	PLEW10008 PL008R PLC008R	
Aruba	PLEW20025	
Ascona Pine Nature	PL052R PLC052R	
Aves Brown	PLEW20012	
Aves Grey	PLEW20011	
Bajo Pine	PLEW20010	
Calistoga Chocolate	PLEW10002	
Calistoga Cream	PLEW10004 PL054R PLC054R	
Calistoga Grey	PLEW10003 PL003R PLC003R	
Calistoga Nature	PLEW10001 PL001R PLC001R	
Canyon Oak	PLEW10007 PL007R PLC007R	
Carmel Pine	PL048R PLC048R	
Dacota Oak	PLEW20017 PL017R PLC017R	
Denali Pine	PLEW20018	
Garden Oak	PLEW10005 PL005R PLC005R	
Island Oak Honey	PL043R PLC043R	
Island Oak Moon	PL045R PLC045R	
Island Oak Sand	PL044R PLC044R	
Malmoe Pine	PLEW20019 PL019R PLC019R	
Monterey Cream	PLEW20024	
Monterey Grey	PLEW20022	
Monterey Rustic	PLEW20023	
Monterey Snow	PLEW20021	
Napa Pine	PLEW20020	
Nevis	PLEW20014	
Nevis Moon	PLEW20015	



18,5/38,5

14,5/50

19/58

15/70

15/80

Art. No. 30060412

Art. No. 30060414

Art. No. 30060431

Art. No. 30060515

Art. No. 30060418

Art. No. 30060417

Art. No. 30060416

Art. No. 30060408

Art. No. 30060410

Art. No. 30060409

Art. No. 30060407

Art. No. 30060413

Art. No. 30060516

Art. No. 30060423

Art. No. 30060424

Art. No. 30060411

Art. No. 30060518

Art. No. 30060519

Art. No. 30060520

Art. No. 30060425

Art. No. 30060430

Art. No. 30060428

Art. No. 30060429

Art. No. 30060427









Art. No. 30060426











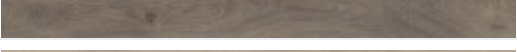

Art. No. 30060420

Art. No. 30060421

FUSSLEISTEN

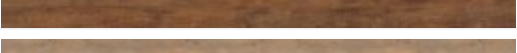
SKIRTING BOARDS | PLINTHES | ZÓCALOS

Design	fit to article	
Nordic Pine Modern	PL050R PLC050R	
Nordic Pine Style	PL049R PLC049R	
Patina Teak	PL046R PLC046R	
Pino Delave	PLEW20013	
Saba	PLEW20009	
Sonoma Oak	PLEW20016	
Summer Beech	PL047R PLC047R	
Traditional Oak Brown	PL051R PLC051R	
Valley Oak Mud	PL042R PLC042R	
Valley Oak Soil	PL041R PLC041R	

Design	fit to article	
Alaska Oak	DEI2308AM	
Arizona Oak Grey	DEI25114AMW CEI25114AMW MLEI25114AMW-N	
Arizona Oak Light Grey	DEI25418AMW CEI25418AMW MLEI25418AMW-N	
Aumera Oak Dark	DB00027 DLC00027	
Aumera Oak Grey	DB00029 DLC00029	
Aumera Oak Native	DB00028 DLC00028	
Aurelia Cream	DB00006 DLC00006	
Aurelia Grey	DB00005 DLC00005	
Aurelia Provence	DB00004 DLC00004	
Boston Pine Brown	DPI71716AMW CPI71716AMW MLPI73217AMW-N	
Boston Pine Cream	DPI71717AMW CPI71717AMW MLPI71717AMW-N	
Boston Pine Grey	DPI71713AMW CPI71713AMW MLPI71713AMW-N	
Bretagne Oak	DEI63614AMW CEI63614AMW MLEI63614AMW-N	
Calm Oak Cream	DB00010 DLC00010	

**18,5 / 38,5****14,5 / 50****19 / 58****15 / 70****15 / 80**



























Art. No.	30060521
Art. No.	30060522
Art. No.	30060523
Art. No.	30060419
Art. No.	30060415
Art. No.	30060422
Art. No.	30060524
Art. No.	30060525
Art. No.	30060526
Art. No.	30060527

18,5 / 38,5**14,5 / 50****19 / 58****15 / 70****15 / 80**

Art. No.	30060474
Art. No.	30060484
Art. No.	30060493
Art. No.	30060464
Art. No.	30060466
Art. No.	30060467
Art. No.	30060453
Art. No.	30060452
Art. No.	30060451
Art. No.	30060494
Art. No.	30060495
Art. No.	30060493
Art. No.	30060489
Art. No.	30060457

FUSSLEISTEN

SKIRTING BOARDS | PLINTHES | ZÓCALOS

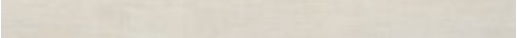
Design	fit to article	
Calm Oak Nature	DB00009 DLC00009	
Chateau Brown	DB00002 DLC00002	
Chateau Grey	DB00003 DLC00003	
Chateau White	DB00001 DLC00001	
Classic Walnut	DNU3116SE CNU3116BA	
Clay Calm Oak	DB00062 DLC00062	
Copenhagen Frosted Pine	DB00076 DLC00076	
Corn Rustic Oak	DB00064 DLC00064	
Country Oak	DEI5004AM	
Cyprus Dark Oak	DB00066 DLC00066	
Denim Oak	DEI2312AM	
Fashion Oak	DEI2309AM	
Golden Canadian Oak	DEI54612AMW CEI54612AMW MLEI54612AMW-N	
Grey Canadian Oak	DEI54615AMW CEI54615AMW MLEI54615AMW-N	
Helsinki Rustic Oak	DB00068 DLC00068	
Highlands Dark	DEI75212AMW CEI75212AMW MLEI75212AMW-N	
Fashion Oak	DEI2309AM	
Golden Canadian Oak	DEI54612AMW CEI54612AMW MLEI54612AMW-N	
Grey Canadian Oak	DEI54615AMW CEI54615AMW MLEI54615AMW-N	
Highlands Dark	DEI75212AMW CEI75212AMW MLEI75212AMW-N	
Highlands Light	DEI75213AMW CEI75213AMW MLEI75213AMW-N	
Honey Warm Maple	DB00081 DLC00081	
Indian Oak	DEI55413AMW CEI55413AMW MLEI55413AMW-N	
Infinity Dark Solid	DB00073	
Infinity Light Solid	DB00074	
Lohas Greige	DPI73217AMW CPI73217AMW MLPI73217AMW-N	
Lohas Light	DPI73212AMW CPI73212AMW MLPI73212AMW-N	



18,5/38,5

14,5/50

19/58

















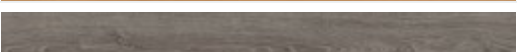







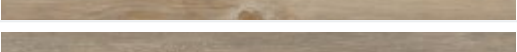

15/70

15/80

Art. No.	30060456
Art. No.	30060449
Art. No.	30060450
Art. No.	30060448
Art. No.	30060446
Art. No.	30060540
Art. No.	30060550
Art. No.	30060542
Art. No.	30060480
Art. No.	30060544
Art. No.	30060476
Art. No.	30060475
Art. No.	30060486
Art. No.	30060487
Art. No.	30060546
Art. No.	30060490
Art. No.	30060475
Art. No.	30060486
Art. No.	30060487
Art. No.	30060490
Art. No.	30060491
Art. No.	30060553
Art. No.	30060488
Art. No.	30060548
Art. No.	30060549
Art. No.	30060497
Art. No.	30060496

FUSSLEISTEN

SKIRTING BOARDS | PLINTHES | ZÓCALOS













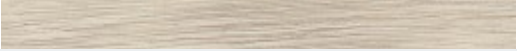

Design	fit to article	
Long Island	DPI101113AMW CPI101113AMW MLPI101113AMW-N	
Lund Dusty Oak	DB00065 DLC00065	
Mud Rustic Oak	DB00063 DLC00063	
Mystic Oak	DEI5005AM	
Native Oak	DEI5001AM	
Natural Apple	CAP61416AMW DAP61416AMW MLAP61416AMW-N	
Ponza Smoky Oak	DB00067 DLC00067	
Riga Vibrant Pine	DB00082 DLC00082	
Salt Lake Oak	DB00079 DLC00079	
Santorini Deep Oak	DB00061 DLC00061	
Sardinia Wild Walnut	DB00083 DLC00083	
Scandic Grey	DB00025 DLC00025	
Scandic White	DB00026 DLC00026	
Sicily Dark Oak	DB00069 DLC00069	
Toscany Pine	DB00007 DLC00007	
Toscany Pine Grey	DB00008 DLC00008	
Venero Oak Beige	DB00013 DLC00013	
Venero Oak Brown	DB00014 DLC00014	
Victoria Oak Grey	DB00030 DLC00030	
Victoria Oak Native	DB00031 DLC00031	
Victoria Oak White	DB00032 DLC00032	
Vintage Antique	DEI1718AM	
Vintage Cream	DEI1716AM	
Vintage Desert	DEI1715AM	
Vintage Mocca	DEI1714AM	
Toscany Pine	DB00007 DLC00007	
Toscany Pine Grey	DB00008 DLC00008	

**18,5/38,5****14,5/50****19/58****15/70****15/80**

Art. No.	30060492
Art. No.	30060543
Art. No.	30060541
Art. No.	30060481
Art. No.	30060477
Art. No.	30060436
Art. No.	30060545
Art. No.	30060554
Art. No.	30060551
Art. No.	30060539
Art. No.	30060555
Art. No.	30060462
Art. No.	30060463
Art. No.	30060547
Art. No.	30060454
Art. No.	30060455
Art. No.	30060458
Art. No.	30060451
Art. No.	30060467
Art. No.	30060458
Art. No.	30060469
Art. No.	30060473
Art. No.	30060472
Art. No.	30060471
Art. No.	30060470
Art. No.	30060454
Art. No.	30060455

FUSSLEISTEN

SKIRTING BOARDS | PLINTHES | ZÓCALOS













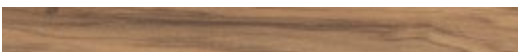











Design	fit to article	
Venero Oak Beige	DB00013 DLC00013	
Venero Oak Brown	DB00014 DLC00014	
Victoria Oak Grey	DB00030 DLC00030	
Victoria Oak Native	DB00031 DLC00031	
Victoria Oak White	DB00032 DLC00032	
Vintage Antique	DEI1718AM	
Vintage Cream	DEI1716AM	
Vintage Desert	DEI1715AM	
Vintage Mocca	DEI1714AM	
Western Oak	DEI5002AM	
Wheat Golden Oak	DLC00080 DB00080	
Wild Apple	DAP61413AMW CAP61413AMW MLAP61413AMW-N	
Woodstock Cream	DB00024 DLC00024	
Woodstock Honey	DB00023 DLC00023	

**18,5/38,5****14,5/50****19/58****15/70****15/80**

Art. No.	30060458
Art. No.	30060451
Art. No.	30060467
Art. No.	30060458
Art. No.	30060469
Art. No.	30060473
Art. No.	30060472
Art. No.	30060471
Art. No.	30060470
Art. No.	30060478
Art. No.	30060552
Art. No.	30060482
Art. No.	30060461
Art. No.	30060460

FUSSLEISTEN

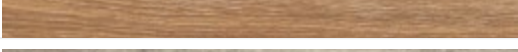
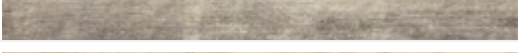
SKIRTING BOARDS | PLINTHES | ZÓCALOS

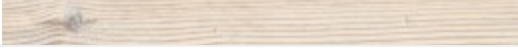



















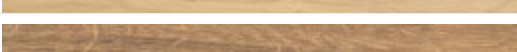
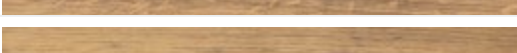

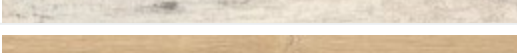

Design	fit to article	
Acacia	LA022M LA022MC	
Alaska Oak	LA054LV2	
Alder Romantic	LA033M LA033MC	
American Pecan	LA055LV2	
Ascona Pine Grey	LA018 LA018C LA018MV2	
Ascona Pine Nature	LA036M LA036MC LA036MV2	
Avenue Oak	LA015 LA015C	
Beech Natural	LA003 LA003C	
Bergamo Oak	LA032M LA032MC	
Californian Oak	LA006 LA006C	
Canadian Maple	LA001 LA001C	
Classic Beech	LA004 LA004C	
Classic Cherry	LA011 LA011C	
Classic Oak	LA010 LA010C	
Coastal Oak	LA028M LA028MC	
Columbian Beech	LA056LV2	
Cornish Oak	LA030M LA030MC	
Country Oak	LA052LV2	
Denali Pine	LA063XLV4	
Garden Oak	LA027M LA027MC	
Globetrotter	LA023M LA023MC	
Husky Oak	LA038M LA038MC	
Kahlua Oak	LA029M LA029MC	
Lumber Grey	LA035M LA035MC	
Lumber White	LA017 LA017C	
Malmoe Pine	LA064XLV4	
Mexican Oak	LA031M LA031MC	



	18,5 / 38,5	14,5 / 50	19 / 58	15 / 70	15 / 80
Art. No.	30030320			30040372	
Art. No.	30030353			30040405	
Art. No.	30030331			30040383	
Art. No.	30030354			30040406	
Art. No.	30030383			30040435	
Art. No.	30030334			30040386	
Art. No.	30030380			30040432	
Art. No.	30030368			30040420	
Art. No.	30030330			30040382	
Art. No.	30030371			30040423	
Art. No.	30030366			30040418	
Art. No.	30030323			30040375	
Art. No.	30030376			30040428	
Art. No.	30030375			30040427	
Art. No.	30030326			30040378	
Art. No.	30030355			30040407	
Art. No.	30030328			30040380	
Art. No.	30030351			30040403	
Art. No.	30030362			30040414	
Art. No.	30030325			30040377	
Art. No.	30030321			30040373	
Art. No.	30030336			30040388	
Art. No.	30030327			30040379	
Art. No.	30030333			30040385	
Art. No.	30030382			30040434	
Art. No.	30030363			30040415	
Art. No.	30030329			30040381	

FUSSLEISTEN

SKIRTING BOARDS | PLINTHES | ZÓCALOS





Design	fit to article	
Michigan Oak	LA057LV2	
Modern Hickory	LA013 LA013C	
Natural Walnut	LA012 LA012C	
Noble Maple	LA002 LA002C	
Nordic Pine Modern	LA020 LA020C	
Nordic Pine Nature	LA019 LA019C	
Oak Champagne	LA051LV2	
Oak Grey	LA026M LA026MC	
Oak Wave Cream	LA059LV2	
Ocean Beech	LA025M LA025MC	
Ocean Oak	LA079MV2	
Ontario Oak	LA053LV2	
Oxford Oak	LA040M LA040MC	
Pepper Oak	LA060LV2	
Pino Delave	LA062XLV4	
Portuguese Oak	LA058LV2	
Tirol Oak Cream	LA043SV4 LA043LV2 LA043XLV4 LA043MV2	
Tirol Oak Grey	LA041SV4 LA041LV2 LA041XLV4 LA041MV2	
Tirol Oak Honey	LA044SV4 LA044LV2 LA044XLV4	
Tirol Oak Nature	LA042SV4 LA042LV2 LA042XLV4	
Tirol Oak Silver	LA045SV4 LA045LV2 LA045XLV4 LA045MV2	
Tirol Oak White	LA046SV4 LA046LV2 LA046XLV4 LA046MV2	
Traditional Oak Brown	LA024M LA024MC LA024SV4 LA024XLV4 LA024MV2	
Traditional Oak Grey	LA048SV4	
Virginia Oak	LA061LV2 LA061MV2	
Walnut Classic	LA034M LA034MC	
Washed Oak	LA050LV2 LA050MV2	





	18,5 / 38,5	14,5 / 50	19 / 58	15 / 70	15 / 80
Art. No.	30030356			30040408	
Art. No.	30030378			30040430	
Art. No.	30030377			30040429	
Art. No.	30030367			30040419	
Art. No.	30030385			30040437	
Art. No.	30030384			30040436	
Art. No.	30030350			30040402	
Art. No.	30030324			30040376	
Art. No.	30030358			30040410	
Art. No.	30030323			30040375	
Art. No.	30030386			30040438	
Art. No.	30030370			30040422	
Art. No.	30030338			30040390	
Art. No.	30030359			30040411	
Art. No.	30030361			30040413	
Art. No.	30030357			30040409	
Art. No.	30030386			30040438	
Art. No.	30030340			30040392	
Art. No.	30030343			30040395	
Art. No.	30030341			30040393	
Art. No.	30030344			30040396	
Art. No.	30030345			30040397	
Art. No.	30030322			30040374	
Art. No.	30030347			30040399	
Art. No.	30030360			30040412	
Art. No.	30030332			30040384	
Art. No.	30030353			30040405	

FUSSLEISTEN

SKIRTING BOARDS | PLINTHES | ZÓCALOS

Design	fit to article	
Welsh Dark Oak	LA009 LA009C LA009SV4	
Welsh Pale Oak	LA008 LA008C LA008SV4	
White Desire	LA037M LA037MC	
White Oak	LA007 LA007C	
Yale Oak	LA039M LA039MC	

Uni-Design	fit to all articles	
Stainless steel polishes		
Stainless steel brushed		
Dark grey		
Light grey		
White		
Black		





	18,5 / 38,5	14,5 / 50	19 / 58	15 / 70	15 / 80
Art. No.	30030333			30040385	
Art. No.	30030373			30040425	
Art. No.	30030335			30040387	
Art. No.	30030372			30040424	
Art. No.	30030337			30040389	

	18,5 / 38,5	14,5 / 50	19 / 58	15 / 70	15 / 80
Art. No.					30060506
Art. No.					30060505
Art. No.		30060434			
Art. No.		30060433			
Art. No.	30030387	30060432	30060435	30040439	30060504
Art. No.				30040440	

UNTERLAGSMATERIAL

UNDERLAY MATERIAL | SOUS-COUCHE | MATERIAL BASE

	silentPREMIUM (selbstklebend*)	silentCOMFORT	Sound-Protect Eco SD	Sound-Protect Eco Profi SD	Sound-Protect Eco
Art.	10020218	UCT1000	10020220	10020221	10020222
Material	Dauerelastisches Unterlagsmaterial aus bis zu 90 % natürlichen Rohstoffen Permanently elastic underlay material made of up to 90 % natural raw materials Sous-couche à élasticité permanente à base de près de 90 % de matières premières naturelles Material de soporte permanentemente elástico hecho hasta de un 90 % de materias primas naturales				
Materialdicke Thickness Épaisseur Grosor	1,8 mm	1,5 mm	2 mm	3 mm	2 mm
Gewicht ca. Weight Poids Peso	2,6 kg/m ²	1,5 kg/m ²	1,7 kg/m ²	2,8 kg/m ²	1,7 kg/m ²
Druckfestigkeit Compressive strength résistance à la compression resistencia a la presión	★★★★★	★★★★★	★★★★★	★★★★★	★★★★★
Wärmedurchlasswiderstand (Eignung Fußbodenheizung) thermal resistance (suitability for underfloor heating) conductivité thermique (Compatible sols chauffants) resistencia de penetración térmica en (idoneidad para calefacciones de suelo)	★★★★★	★★★★★	★★★★★	★★★★★	★★★★★
Resteindruck residual indentation poinçonnement rémanent huella residual	★★★★★	★★★★★	n.r.	n.r.	n.r.
Gehschallemission reflected walking sound émission des bruits de resonance emisión acústica de pasos	n.r.	n.r.	★★★★	★★★★	★★★★
Trittschallreduzierung impact sound reduction atténuation des bruits de pas reducción acústica de las pisadas	★★★	★★★	★★★★	★★★★	★★★★
Ausgleich von Unebenheiten uneven surface compensation compensation des inégalités compensación de irregularidades	★★	★★	★★★	★★★★	★★★
Lebensdauer lifetime durée de vie duración de vida	★★★★★				
Feuchteschutz (integr. Dampfbremse) humidity protection protection contre humidité protección contra humedad	n.r.	n.r.	✓	✓	✗
Eignung Suitability Aptitude Idoneidad	winea 1000				
	für NK** ≤ 32				
	Kleben to glue coller encolar	Klicken to click clic encajar	mineralischer Untergrund mineral ground support minéral superficie minerales		nicht-mineralischer Untergrund non-mineral ground aucun support minéral ningún superficie minerales

1 ★ = gut | good | bon | bien

5 ★★★★★ = sehr gut | very good | tres bien | excelente

n.r. = nicht relevant | not relevant | pas pertinent | irrelevante

✓ = ja | yes | oui | sí

✗ = nein | no | non | no

* self-adhesive | autoadhésif | autoadhesiva

** NK = Nutzungsklasse | Utilisation class | Classe d'usage | Clase de uso

■ PURLINE BIOBODEN | PURLINE ORGANIC FLOORING | PURLINE SOL ORGANIQUE | PURLINE SUELO BIO

■ DESIGNBODEN | DESIGN FLOORING | SOL DESIGN | SUELO DE DISEÑO

■ LAMINATBODEN | LAMINATE FLOORING | SOL STRATIFIÉ | SUELO LAMINADO

Sound-Protect Eco Profi	Noise-Protect SD	Noise-Protect Profi SD	Noise Protect	Noise-Reduct	Noise-Reduct SD	Dämmplatte
10020223	10020226	10020227	10020228	10020225	10020230	10020229
	PE-Unterlagsschaum PE underlay foam mousse de base PE espuma base de PE			XPS-Unterlagsschaum XPS underlay foam mousse de base XPS espuma base de XPS		Holzfasерplatte fibreboard panneau de fibre fibra de madera
3 mm	2,5 mm	2,2 mm	2 mm	2 mm	2 mm	5 mm
2,8 kg/m ²	0,21 kg/m ²	0,32 kg/m ²	0,20 kg/m ²	0,09 kg/m ²	0,09 kg/m ²	1,65 kg/m ²
★★★★★	★	★★	★★	★★★	★★★	★★★★★
★★★★★	★★★	★★★★	★★★★	★	★	✗
n.r.	n.r.	n.r.	n.r.	n.r.	n.r.	n.r.
★★★★	★	★★★	★★★	★★	★★	★
★★★★	★★★★	★★★★	★★★★	★★★★	★★★★	★★★★★
★★★★	★★★★	★★★★	★★★★	★★★	★★★	★★★★★
	★	★★	★★	★★★★		★★★★★
✗	✓	✓	✗	✗	✓	✗
nicht-mineralischer Untergrund non-mineral ground aucun support minéral ningún superficie minerales	mineralischer Untergrund mineral ground support minéral superficie minerales		nicht-mineralischer Untergrund non-mineral ground aucun support minéral ningún superficie minerales		mineralischer Untergrund mineral ground support minéral superficie minerales	nicht-mineralischer Untergrund non-mineral ground aucun support minéral ningún superficie minerales

Sound Protect Eco
Parkett geeignet
suitable for parquet
Egalement compatible
sous les parquets
adecuado
por es suelo de
parquet

UNTERLAGSMATERIAL

UNDERLAY MATERIAL | SOUS-COUCHE | MATERIAL BASE

wineo silentPREMIUM

selbstklebend | self-adhesive | autocollante | autoadhesiva

- Dauerelastisches Unterlagsmaterial aus bis zu 90 % natürlichen Rohstoffen | Permanently elastic underlay material made of up to 90 % natural raw materials | Sous-couche à élasticité permanente à base de près de 90 % de matières premières naturelles | Material de soporte permanentemente elástico hecho hasta de un 90 % de materias primas naturales
- Dauerhaft hervorragende Trittschalleigenschaften | Permanently outstanding impact sound properties | Excellente durabilité des propriétés de réduction des bruits de résonance et de pas | Propiedades de reducción acústica de las pisadas
- Überbrückung von Untergrundunebenheiten | Bridges uneven patches in the subfloor | Corrige les inégalités de support | corrección de las irregularidades del suelo
- Erhöhung des Verlegekomforts | Increases installation ease and comfort | Augmente le confort de pose | Aumento de la comodidad de instalación
- Optimal geeignet für Fußbodenheizung | Most suitable for underfloor heating | Convient parfaitement au chauffage par le sol | Especialmente adecuada para suelos radiantes
- Geeignet für PURLINE Bioboden und wineo Designboden zum Kleben | Suitable for PURLINE organic flooring and wineo design flooring to glue | Parfaitement adapté à la mise en œuvre du PURLINE Sol Organique et aux sols design wineo à coller | Adecuada para PURLINE suelo bio y suelo de diseño wineo para encolar
- Dank selbstklebender Oberfläche kein zusätzlicher Klebstoff erforderlich | No additional adhesive necessary due to the self-adhesive surface | Grâce à sa surface autocollante, pas besoin de colle | Gracias a la superficie autoadhesiva, no es necesario ningún adhesivo adicional



silentPREMIUM

Art. no. 10020218

Box = 40 Rollen/Palette | rolls/pallet | rouleaux/palette | rollos/palé | 6,5m²/Rolle | roll | rouleau | rollo

1,8mm Stärke | thickness | épaisseur/grosor | 1 m Breite | width | largeur | ancho

6,5m Länge | length | longueur | largo | 2,6kg/m² Gewicht | weight | poids | peso

13dB wineo PURLINE BIOBODEN | PURLINE ORGANIC FLOORING |
PURLINE SOL ORGANIQUE | PURLINE SUELO BIO

15dB wineo DESIGNBODEN | DESIGN FLOORING | SOL DESIGN | SUELO DE DISEÑO

0,01 (m²K)/W Wärmedurchlasswiderstand | thermal resistance | conductivité thermique | resistencia de penetración térmica

wineo silentCOMFORT

- Dauerelastisches Unterlagsmaterial aus bis zu 90 % natürlichen Rohstoffen | Permanently elastic underlay material made of up to 90 % natural raw materials | Sous-couche à élasticité permanente à base de près de 90 % de matières premières naturelles | Material de soporte permanentemente elástico hecho hasta de un 90 % de materias primas naturales
- Dauerhaft hervorragende Trittschalleigenschaften | Permanently outstanding impact sound properties | Excellente durabilité des propriétés de réduction des bruits de résonance et de pas | Propiedades de reducción acústica de las pisadas
- Überbrückung von Untergrundunebenheiten | Bridges uneven patches in the subfloor | Corrige les inégalités de support | corrección de las irregularidades del suelo
- Erhöhung des Verlegekomforts | Increases installation comfort | Augmente le confort de pose | Aumento de la comodidad de instalación
- Optimal geeignet für Fußbodenheizung | Most suitable for underfloor heating | Convient parfaitement au chauffage par le sol | Especialmente adecuada para suelos radiantes
- Geeignet für PURLINE Bioboden und wineo Designboden zum Klicken | Suitable for PURLINE organic flooring and wineo design flooring for clicking in | Parfaitement adapté à la mise en œuvre du PURLINE Sol Organique et aux sols design wineo à cliquer | Adecuada para PURLINE suelo bio y suelo de diseño wineo para encajar
- Erhöhung des Antirutscheffektes | Improvement non-slip effect | Amélioration de l'effet antidérapant | remedio de efecto antideslizante



silentCOMFORT Art. no. UCT1000

Box = 40 Rollen/Palette | rolls/pallet | rouleaux/palette | rollos/palé | 10m²/Rolle | roll | rouleau | rollo

1,5mm Stärke | thickness | épaisseur/grosor | 1m Breite | width | largeur | ancho

10m Länge | length | longueur | largo | 1,5kg/m² Gewicht | weight | poids | peso

14dB wineo PURLINE BIOBODEN | PURLINE ORGANIC FLOORING |
PURLINE SOL ORGANIQUE | PURLINE SUELO BIO

14dB wineo DESIGNBODEN | DESIGN FLOORING | SOL DESIGN | SUELO DE DISEÑO

0,01 (m²K)/W Wärmedurchlasswiderstand | thermal resistance/ conductivité thermique | resistencia de penetración térmica

UNTERLAGSMATERIAL

UNDERLAY MATERIAL | SOUS-COUCHE | MATERIAL BASE

wineo Sound-Protect Eco

mit integrierter Dampfbremse | with integrated vapour barrier | avec pare-vapeur PE intégré | con barrera de vapor integrada

- Dauerelastisches Unterlagsmaterial aus bis zu 90 % natürlichen Rohstoffen | Permanently elastic underlay material made of up to 90 % natural raw materials | Sous-couche à élasticité permanente à base de près de 90 % de matières premières naturelles | Material de soporte permanentemente elástico hecho hasta de un 90 % de materias primas naturales
- Dauerhaft hervorragende Geh- und Trittschalleigenschaften | Permanently outstanding impact sound properties | Excellente durabilité des propriétés de réduction des bruits de résonance et de pas | Propiedades de reducción acústica de las pisadas
- Optimal geeignet für Fußbodenheizung | Most suitable for underfloor heating | Convient parfaitement au chauffage par le sol | Especialmente adecuada para suelos radiantes
- Geeignet für alle mineralischen Untergründe | Suitable for all mineral sub floors | Compatible sur tout support minéral | Adecuada para todas superficies minerales
- Integrierte Dampfbremse bei Verkleben der Stoßkanten mit Combi-Dichtband | Integrated vapour barrier when adhering the seams with combi sealing tape | Pare-vapeur intégré en cas de collage des rebords avec bande d'étanchéité combinée | Barrera de vapor integrada al encolar el borde con cinta selladora combi

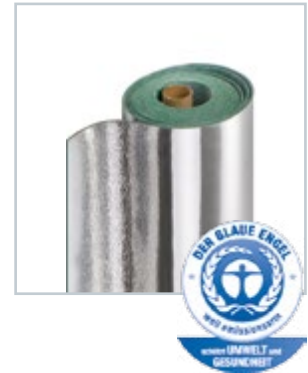

Sound-Protect Eco Profi SD

Art. no. 10020221

Box = 40 Rollen/Palette | rolls/pallet | rouleaux/palette | rollos/palé | 5,5m²/Rolle | roll | rouleau | rollo
3mm Stärke | thickness | épaisseur | grosor | 1m Breite | width | largeur | ancho
5,5m Länge | length | longueur | largo | 2,8kg/m² Gewicht | weight | poids | peso

~ 20dB | ca. 31 % Gehschallemission | reflected walking sound | émission des bruits de resonance
emisión acústica de pasos

0,01 (m²K)/W Wärmedurchlasswiderstand | thermal resistance | conductivité thermique | resistencia
de penetración térmica

SD-Wert: ≥ 75m

Sound-Protect Eco SD

Art. no. 10020220

Box = 40 Rollen/Palette | rolls/pallet | rouleaux/palette | rollos/palé | 8m²/Rolle | roll | rouleau | rollo
2mm Stärke | thickness | épaisseur | grosor | 1m Breite | width | largeur | ancho
8m Länge | length | longueur | largo | 1,7kg/m² Gewicht | weight | poids | peso

~ 19dB | ca. 28 % Gehschallemission | reflected walking sound | émission des bruits de
resonance | emisión acústica de pasos

0,01 (m²K)/W Wärmedurchlasswiderstand | thermal resistance | conductivité thermique | resistencia
de penetración térmica

SD-Wert: ≥ 75m

wineo Sound-Protect Eco

- Dauerelastisches Unterlagsmaterial aus bis zu 90 % natürlichen Rohstoffen | Permanently elastic underlay material made of up to 90 % natural raw materials | Sous-couche à élasticité permanente à base de près de 90 % de matières premières naturelles | Material de soporte permanentemente elástico hecho hasta de un 90 % de materias primas naturales
- Dauerhaft hervorragende Geh- und Trittschalleigenschaften | Permanently outstanding impact sound properties | Excellente durabilité des propriétés de réduction des bruits de résonance et de pas | Propiedades de reducción acústica de las pisadas
- Optimal geeignet für Fußbodenheizung | Most suitable for underfloor heating | Convient parfaitement au chauffage par le sol | Especialmente adecuada para suelos radiantes
- Geeignet für alle nicht-mineralischen Untergründe | Suitable for all non-mineral sub floors | Compatible sur tout support non minéral | Adecuada para todas superficies no minerales (für mineralische Untergründe nur in Verbindung mit Dampfbremse) | (for mineral sub floors in conjunction with vapour barrier only) | (mise en œuvre sur support minéral uniquement en combinaison avec un pare-vapeur) | (para los subsuelos minerales en combinación con barrera de vapor)



Sound-Protect Eco Profi

Art. no. 10020223

Box = 40 Rollen/Palette | rolls/pallet | rouleaux/palette | rollos/palé | 5,5 m²/Rolle | roll | rouleau | rollo

3 mm Stärke | thickness | épaisseur | grosor | 1 m Breite | width | largeur | ancho

5,5 m Länge | length | longueur | largo | 2,8 kg/m² Gewicht | weight | poids | peso

~ 20 dB | ca. 31 % Gehschallemission | reflected walking sound | émission des bruits de resonance
emisión acústica de pasos

0,01 (m²K)/W Wärmedurchlasswiderstand | thermal resistance | conductivité thermique | resistencia
de penetración térmica

Sound-Protect Eco

Art. no. 10020222

Box = 40 Rollen/Palette | rolls/pallet | rouleaux/palette | rollos/palé | 8 m²/Rolle | roll | rouleau | rollo

2 mm Stärke | thickness | épaisseur | grosor | 1 m Breite | width | largeur | ancho

8 m Länge | length | longueur | largo | 1,7 kg/m² Gewicht | weight | poids | peso

~ 19 dB | ca. 28 % Gehschallemission | reflected walking sound | émission des bruits de
resonance | emisión acústica de pasos

0,01 (m²K)/W Wärmedurchlasswiderstand | thermal resistance | conductivité thermique | resistencia
de penetración térmica

wineo Noise-Protect

mit integrierter Dampfbremse | with integrated vapour barrier | avec pare-vapeur PE intégré | con barrera de vapor integrada

- PE-Unterlagsschaum | PE underlay foam | mousse de base PE | espuma base de PE
- Gute Geh- und Trittschalleigenschaften | good impact sound properties | Bonne durabilité des propriétés de réduction des bruits de résonance | Propiedades de reducción acústica de las
- Optimal geeignet für Fußbodenheizung | Most suitable for underfloor heating | Convient parfaitement au chauffage par le sol | Especialmente adecuada para suelos radiantes
- Geeignet für alle mineralischen Untergründe | Suitable for all mineral sub floors | Compatible sur tout support minéral | Adecuada para todas superficies minerales
- Integrierte Dampfbremse inkl. überlappender Verklebung | Integrated vapour barrier inclusive overlapping adhesive | Pare-vapeur intégré inclus le collage en chevauchement | Barrera de vapor integrada incluido el pegado de solapamiento

Noise-Protect Profi SD

Art. no. 10020227

Box = 20 Rollen/Palette | rolls/pallet | rouleaux/palette | rollos/palé | 15m²/Rolle | roll | rouleau | rollo

2,2mm Stärke | thickness | épaisseur | grosor | 1 m Breite | width | largeur | ancho

15m Länge | length | longueur | largo | 0,26 kg/m² Gewicht | weight | poids | peso

~ 19dB | 15% Gehschallemission | reflected walking sound | émission des bruits de resonance | emisión acústica de pasos | SD-Wert: ≥ 75m

Noise-Protect SD

Art. no. 10020226

Box = 2 Rollen/Sack | rolls/bag | rouleaux/sac | rollos/saco | 30m²/Rolle | roll | rouleau | rollo

2,5mm Stärke | thickness | épaisseur | grosor | 1 m Breite | width | largeur | ancho

30m Länge | length | longueur | largo | 0,13 kg/m² Gewicht | weight | poids | peso

~ 19dB | 7% Gehschallemission | reflected walking sound | émission des bruits de resonance | emisión acústica de pasos | SD-Wert: ≥ 75m

wineo Noise-Protect

- PE-Unterlagsschaum | PE underlay foam | mousse de base PE | espuma base de PE
- Gute Geh- und Trittschalleigenschaften | good impact sound properties | bon durabilité des propriétés de réduction
- Optimal geeignet für Fußbodenheizung | Most suitable for underfloor heating | Convient parfaitement au chauffage par le sol | Especialmente adecuada para suelos radiantes
- Geeignet für alle nicht-mineralischen Untergründe | Suitable for all non-mineral sub floors | Compatible sur tout support non minéral | Adecuada para todas superficies no minerales (für mineralische Untergründe nur in Verbindung mit Dampfbremse) | (for mineral sub floors in conjunction with vapour barrier only) | (pour les supports minéraux uniquement en combinaison avec un pare-vapeur) | (para los subsuelos minerales en combinación con barrera de vapor)

Noise-Protect Profi

Art. no. 10020228

Box = 6 Rollen/Karton | rolls/cardboard | rouleaux/carton | rollos/cartón | 15m²/Rolle | roll | rouleau | rollo

2mm Stärke | thickness | épaisseur | grosor | 1 m Breite | width | largeur | ancho

15m Länge | length | longueur | largo | 0,26 kg/m² Gewicht | weight | poids | peso

~ 19dB | 15% Gehschallemission | reflected walking sound | émission des bruits de resonance | emisión acústica de pasos



wineo Noise-Reduct

mit integrierter Dampfbremse | with integrated vapour barrier | avec pare-vapeur PE intégré | con barrera de vapor integrada

- XPS-Unterlagsschaum mit guter Wärmedämmung | XPS underlay foam with good heat insulation | Mousse de base XPS avec bonne isolation thermique | Espuma base de XPS con buen aislamiento térmico
- Sehr gute Trittschalleigenschaften | Very good impact sound properties | Très bonne durabilité des propriétés de réduction des bruits de résonance | Propiedades de reducción acústica de las pisadas muy bien
- Nicht geeignet für Fußbodenheizung | Not suitable for underfloor heating | Ne convient pas au chauffage par le sol | No adecuada para suelos radiantes
- Geeignet für alle mineralischen Untergründe | Suitable for all mineral sub floors | Compatible sur tout support minéral | Adecuada para todos superficies minerales
- Integrierte Dampfbremse inkl. überlappender Verklebung | Integrated vapour barrier inclusive overlapping adhesive | Pare-vapeur intégré inclus le collage en chevauchement | Barrera de vapor integrada incluido el pegado de solapamiento



Noise-Reduct SD

Art. no. 10020230

Box = 48 Rollen/Palette | rolls/pallet | rouleaux/palette | rollos/palé | 15 m²/Rolle | roll | rouleau | rollo

2mm Stärke | thickness | épaisseur | grosor | 1 m Breite | width | largeur | ancho

15m Länge | length | longueur | largo | 0,08 kg/m² Gewicht | weight | poids | peso

~ 20 dB | 12 % Gehschallemission | reflected walking sound | émission des bruits de resonance
emisión acústica de pasos

SD-Wert: ≥ 75m

wineo Noise-Reduct

- XPS-Unterlagsschaum mit guter Wärmedämmung | XPS underlay foam with good heat insulation | Mousse de base XPS avec bonne isolation thermique | Espuma base de XPS con buen aislamiento térmico
- Sehr gute Trittschalleigenschaften | Very good impact sound properties | Très bonne durabilité des propriétés de réduction des bruits de résonance | Propiedades de reducción acústica de las pisadas muy bien
- Nicht geeignet für Fußbodenheizung | Not suitable for underfloor heating | Ne convient pas au chauffage par le sol | No adecuada para suelos radiantes
- Geeignet für alle nicht-mineralischen Untergründe | Suitable for all non-mineral sub floors | Compatible sur tout support non minéral | Adecuada para todos superficies no minerales (für mineralische Untergründe nur in Verbindung mit Dampfbremse) | (for mineral sub floors in conjunction with vapour barrier only) | (pour les supports minéraux uniquement en combinaison avec un pare-vapeur) | (para los subsuelos minerales en combinación con barrera de vapor)



Noise-Reduct

Art. no. 10020225

Box = 48 Rollen/Palette | rolls/pallet | rouleaux/palette | rollos/palé | 16,5 m²/Rolle | roll | rouleau | rollo

2mm Stärke | thickness | épaisseur | grosor | 1,1 m Breite | width | largeur | ancho

15m Länge | length | longueur | largo | 0,08 kg/m² Gewicht | weight | poids | peso

~ 20 dB | 12 % Gehschallemission | reflected walking sound | émission des bruits de resonance
emisión acústica de pasos

wineo Dämmplatte | wineo insulation board | Panneau isolant de wineo | Placa aislante wineo

- Holzfaserplatte mit guter Wärmedämmung | Fibreboard panel with good heat insulation
Panneau de fibres avec bonne isolation thermique | Paneles de fibras de madera con buen aislamiento térmico
- Dauerhaft hervorragende Trittschalleigenschaften | Permanently outstanding impact sound properties | Excellente durabilité des propriétés de réduction des bruits de résonance et de pas | Propiedades de reducción acústica de las pisadas
- Ermöglicht einen Höhenausgleich bis ca. 3 mm | Enables a height adjustment up to approx. 3 mm/Permet un ajustement en hauteur jusqu'à env. 3 mm | Permite un ajuste de altura de hasta 3 mm
- Nicht geeignet für Fußbodenheizung | Not suitable for underfloor heating | Ne convient pas au chauffage par le sol | No adecuada para suelos radiantes
- Geeignet für alle nicht-mineralischen Untergründe | Suitable for all non-mineral sub floors
Compatible sur tout support non minéral | Adecuada para todos superficies no minerales (für mineralische Untergründe nur in Verbindung mit Dampfbremse) | (for mineral sub floors in conjunction with vapour barrier only) | (pour les supports minéraux uniquement en combinaison avec un pare-vapeur) | (para los subsuelos minerales en combinación con barrera de vapor)

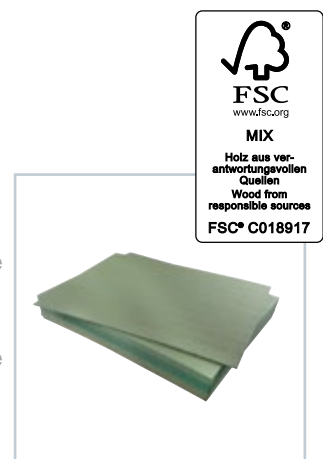

Dämmplatte | insulation board | Panneau isolant de | Placa aislante

Art. no. 10020229

Box = 24 Pakete/Palette | boxes/pallet | paquets/palette | cajas/palé | 1 Paket/7 m² (15 Stück | 15 pieces | 15 unités | 15 piezas)

5 mm Stärke | thickness | épaisseur | grosor | 0,59 m Breite | width | largeur | ancho
0,79 m Länge | length | longueur | largo | 1,65 kg/m² Gewicht | weight | poids | peso

~ 22 dB | 11 % Gehschallemission | reflected walking sound | émission des bruits de resonance | emisión acústica de pasos

wineo PE-Dampfbremse | PE vapour barrier | PE Pare-vapeur PE Barrera de vapor

- Dünne PE-Folie für den Einsatz unter allen Hartbodenbelägen (nicht erforderlich bei Holzuntergründen) | Thin PE film for use underneath all resilient floor coverings (not necessary with wooden subfloors) | Film PE fin pour une utilisation sous tous les revêtements de sol durs (non requis pour les supports en bois) | Lámina fina de PE para el uso bajo de todos los recubrimientos de suelo duros (no necesaria para en subsuelos de madera)
- Dient als Trennlage zwischen Estrich und Dämmunterlage | Acts as separation layer between screed and underlay material | Sert de couche de séparation entre la chape et la sous-couche isolante | Sirve de capa de separación entre el pavimento y la base de aislamiento
- B2 zertifiziert | B2 certified | Certification B2 | Certificación B2



PE-Dampfbremse | PE vapour barrier | PE Pare-vapeur PE Barrera de vapor

Art. no. 10100015

Box = 100 Rollen/Palette | rolls/pallet | rouleaux/palette | rollos/palé | 30 m²/Rolle | roll | rouleau | rollo

0,125 mm Stärke | thickness | épaisseur | grosor | 1 m Breite | width | largeur | ancho
30 m Länge | length | longueur | largo

wineo Combi-Dichtband | wineo combi sealing tape | Bande d'étanchéité combinée de wineo | Cinta selladora combi wineo

- Spezialklebeband zum Abdichten der Stoßkanten von Dämmunterlagen | Special adhesive tape for sealing the end edges of insulating underlays | Bande adhésive d'étanchéité, pour jonction des lés des sous couche | Cinta adhesiva especial para sellar los bordes de las bases de aislamiento
- Erforderlich zu allen Dämmmatten mit integrierter Dampfbremse | Required for all insulation mats with integrated vapour barrier | Requisite pour toutes les sous-couches inutile avec pare vapeur intégré à recouvrement | Necesarias para todas las estrillas aislantes con barrea de vapour integrada



Combi-Dichtband | combi sealing tape | Bande d'étanchéité combinée de Cinta selladora combi wineo Art. no. 100206022





Box = 1 Rolle | roll | rouleau | rollo

50 mm Breite | width | largeur | ancho | 50 m Länge | length | longueur | largo

AKZENTSTREIFEN | FEATURE STRIPS | JOINTS EFFET CARRELAGE | FRANJAS DECORATIVAS

Für eine Planken- oder Fliesenoptik mit Fugen-Effekt. | For a natural look of planks or tiles with joint effect.
Souligner l'aspect naturel des lames ou des dalles avec un effet joint décoratif | Subrayar un aspecto natural de tablas o de baldosas con un efecto de juntas.



















Breite width largeur ancho	5 mm
Stärke thickness épaisseur grosor	2 mm/2,5 mm
Länge length longueur largo	1000 mm
Box	50 m

Uni-Design	2 mm	2,5 mm	
Anthracite	AAN20DL	AAN25DL	
Cream	ACR20DL	ACR25DL	
Dark brown	ADB20DL	ADB25DL	
Black	ASW20DL	ASW25DL	
Silver grey	ASG20DL	ASG25DL	

HOCHZÜGE, AUSSENECKEN & SCHMELZDRÄHTE

SKIRTING BOARDS, EXTERNAL CORNERS AND WELD RODS | REMONTÉES DE PLINTHES, ANGLES EXTÉRIEURS ET CORDONS DE SOUDURE | RODAPIÉS, ESQUINAS EXTERIORES Y CORDONES DE SOLDADURA

- Für den Einsatz im Health & Care Bereich | For use in Health & Care | Pour l'usage dans le secteur Health & Care
Para el uso en el área Health & Care
- Für saubere Wandabschlüsse, wo Hygiene notwendig ist | Ensure a proper wall finish where hygiene is essential
Assurent une finition murale nette où l'hygiène est essentielle | proporcionar un acabado a un pared limpio donde la higiene es esencial
- In jedem Design der Kollektion erhältlich | Available in every collection design | Dans tous les designs des collections disponible | En cada diseño de las colecciones disponible
- Schmelzdrähte sind dekorgleich erhältlich | Fusewires are available which are similar to the decor | Cordons de soudure sont disponible dans la couleur du décor | Cordones de soldadura estan disponible en el color de decorativo

Design	fit to article	
Almond Chip	PB00029RE	
Antique White	PB00001LE	
Apple Green	PB00185LE	
Biskaya Cherry	PB00041TI	
Blue Lagoon	PB00015LE	
Camel Chip	PB00031RE	
Cappuccino	PB00004LE	
Carbon Chip	PB00034RE	
Chocolate Chip	PB00035RE	
Columbia Walnut	PB00042TI	
Cosmic Black	PB00027RE	
Cosmic White	PB00026RE	
Cottage Oak	PB00038TI	
Crazy Boat	PB00044AR (Crazy Fish)	
Cream Chip	PB00030RE	
Golden Chip	PB00028RE	
Golden Yellow	PB00006LE	
Halifax Oak	PB00036TI	

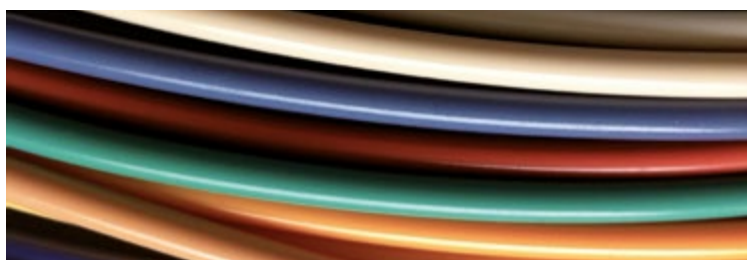

	Skirting Boards	External Corners	Weld rods
Height	100 mm	100 mm	4 mm
Depth	100 mm	100 mm	4 mm
Length	2400 mm	230 mm je Seite either les deux los dos	60 m/Rolle roll rouleau rollo
Box	10 Stück pieces unités piezas	10 Stück pieces unités piezas	1 Rolle roll rouleau rollo

Hochzüge
Skirting Boards
Remontées de plinthes
Rodapiés

Aussenecken
External Corners
Angles Extérieures
Esquinas Exteriores

Schmelzdrähte
Weld rods
Cordons de Soudure
Cordones de Soldadura

PH00074RE

PE00121RE

PS00166RE

PH00046LE

PE00093LE

PS00138LE

PH00186LE

PE00187LE

PS00188LE

PH00086TI

PE00133TI

PS00178TI

PH00060LE

PE00107LE

PS00152LE

PH00076RE

PE00123RE

PS00168RE

PH00049LE

PE00096LE

PS00141LE

PH00079RE

PE00126RE

PS00171RE

PH00080RE

PE00127RE

PS00172RE

PH00087TI

PE00134TI

PS00179TI

PH00072RE

PE00119RE

PS00164RE

PH00071RE

PE00118RE

PS00163RE

PH00083TI

PE00130TI

PS00175TI

PB00092AR

PE00184AR

PS00181AR

PH00075RE

PE00122RE

PS00167RE

PH00073RE

PE00120RE

PS00165RE

PH00051LE

PE00098LE

PS00143LE

PH00081TI

PE00128TI

PS00173TI

Happy Animals	PB00043AR (Happy Jungle)	
Happy Elephants	PB00043AR (Happy Jungle)	
Honey Mustard	PB00005LE	
Jungle Green	PB00018LE	
Lavender Field	PB00012LE	
Alphabet Dance	PB00045AR (Letter Dance)	
Kids Dance	PB00045AR (Letter Dance)	
Light Apricot	PB00007LE	
Light Grey	PB00021LE	
Melange	PB00003LE	
Midnight Blue	PB00017LE	
Midnight Grey	PB00024LE	
Missouri Oak	PB00039TI	
Moonlight Chip	PB00033RE	
Navy Blue	PB00016LE	
Pacific Oak	PB00037TI	
Pure Black	PB00194UN	
Pure White	PB00025RE	
Purple Rain	PB00013LE	
Racing Green	PB00019LE	
Red Berry	PB00010LE	
Red Rubin	PB00011LE	
Silver Chip	PB00032RE	
Silver Grey	PB00022LE	
Sinai Sand	PB00002LE	
Spring Green	PB00020LE	
Steamed Beech	PB00040TI	
Steel Grey	PB00023LE	
Summer Sky	PB00014LE	
Terracotta Dark	PB00009LE	
Terracotta Light	PB00008LE	

PH00088AR	PE00135AR	PS00180AR
PH00089AR	PE00136AR	PS00180AR
PH00050LE	PE00097LE	PS00142LE
PH00063LE	PE00110LE	PS00155LE
PH00057LE	PE00104LE	PS00149LE
PH00091AR	PE00183AR	PS00182AR
PH00090AR	PE00137AR	PS00182AR
PH00052LE	PE00099LE	PS00144LE
PH00066LE	PE00113LE	PS00158LE
PH00048LE	PE00095LE	PS00140LE
PH00062LE	PE00109LE	PS00154LE
PH00069LE	PE00116LE	PS00161LE
PH00084TI	PE00131TI	PS00176TI
PH00078RE	PE00125RE	PS00170RE
PH00061LE	PE00108LE	PS00153LE
PH00082TI	PE00129TI	PS00174TI
PH00195UN	PE00196UN	PS00197UN
PH00070RE	PE00117RE	PS00162RE
PH00058LE	PE00105LE	PS00150LE
PH00064LE	PE00111LE	PS00156LE
PH00055LE	PE00102LE	PS00147LE
PH00056LE	PE00103LE	PS00148LE
PH00077RE	PE00124RE	PS00169RE
PH00067LE	PE00114LE	PS00159LE
PH00047LE	PE00094LE	PS00139LE
PH00065LE	PE00112LE	PS00157LE
PH00085TI	PE00132TI	PS00177TI
PH00068LE	PE00115LE	PS00160LE
PH00059LE	PE00106LE	PS00151LE
PH00054LE	PE00101LE	PS00146LE
PH00053LE	PE00100LE	PS00145LE

ALUMINIUMPROFILE IN HOLZ- UND METALLOPTIK ALUMINIUM PROFILES IN WOOD AND METAL FINISH PROFILÉS ALUMINIUM ASPECT BOIS ET METAL PERFILES DE ALUMINIO EN OPTICA DE MADERA Y METAL

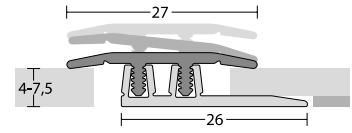

Übergangprofil Profi-Design | Transition profile Profi-Design | Profilés de transition Profi-Design | Perfiles des transición Profi-Design

für Belagstärken von 4–7,5 mm, Breite 27 mm | for floor covering thicknesses of 4–7,5 mm, width 27 mm | pour des épaisseurs de revêtement de 4 à 7,5 mm, largeur 27 mm | para grosos de revestimiento de 4–7,5 mm, ancho 27 mm

Zweiteiliges Aluminiumprofil zur Überdeckung von Dehnungsfugen | Two-part aluminium profile for covering expansion joints | Profilé aluminium en deux parties pour recouvrir des joints de fractionnement | Perfil de aluminio de dos partes para recubrir las juntas de dilatación

Box = 10 Stück/Karton | pieces/box | unités/carton | piezas/cartón | Mindestbestellmenge | minimum order size | commande minimum | pedido mínimo = 1 Stück | pieces | unités | piezas

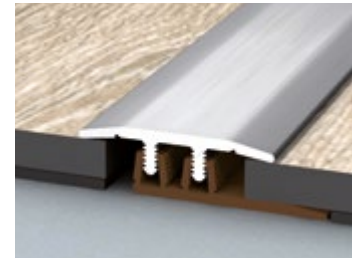

Uni-Design	1 m	2,7 m	
Stainless stell brushed	48100491	48100476	
Stainless steel matt	48100489	48100474	
Stainless stell polishes	48100490	48100475	
Sand	48100487	48100472	
Silver	48100488	48100473	



Übergangsprofil Profitec Junior | Transition profile Profitec Junior | Profilés de transition Profitec Junior | Perfiles des transición Profitec Junior

für Belagstärken von 6–12 mm, Breite 33 mm | for floor covering thicknesses of 6–12 mm, width 33 mm | pour des épaisseurs de revêtement de 6 à 12 mm, largeur 33 mm | para grosores de revestimiento de 6–12, ancho 33 mm

Zweiteiliges Aluminiumprofil zur Überdeckung von Dehnungsfugen | Two-part aluminium profile for covering expansion joints | Profilé aluminium en deux parties pour recouvrir des joints de fractionnement | Perfil de aluminio de dos partes para recubrir las juntas de dilatación

Box = 10 Stück/Karton | pieces/box | unités/carton | piezas/cartón | Mindestbestellmenge | minimum order size | commande minimum | pedido mínimo = 1 Stück | pieces | unités | piezas

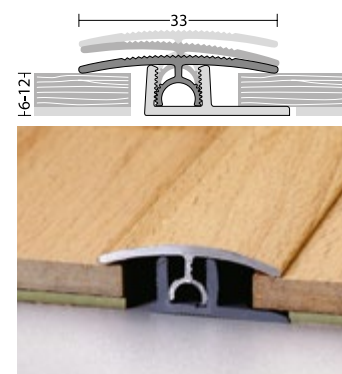

Design	1 m	2,7 m	
Maple		48100429	
Beech		48100427	
Stainless steel matt	48100450	48100426	
Oak light		48100428	
Cherry		48100430	
Nutwood		48100431	
Silver	48100449	48100425	
Sand	48100448	48100424	

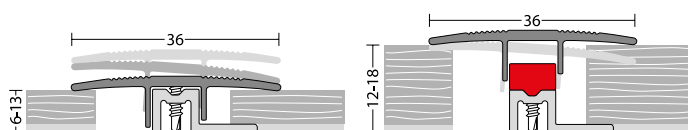

Übergangsprofil PS400PEP | Transition profile PS400PEP | Profilés de transition PS400PEP | Perfiles des transición PS400PEP

für Belagstärken von 6–13 mm, Breite 36 mm | for floor covering thicknesses of 6–13 mm, width 36 mm | pour des épaisseurs de revêtement de 6 à 13 mm, largeur 36 mm | para grosores de revestimiento de 6–13, ancho 36 mm

Geschraubtes zweiteiliges Aluminiumprofil zur Überdeckung von Dehnungsfugen | Bolted Two-part aluminium profile for covering expansion joints | Profile aluminium épaisseur en deux parties pour recouvrir des joints de fractionnement | Perfil de aluminio reapretado de dos partes para recubrir las juntas de dilatación

Box = 10 Stück/Karton | pieces/box | unités/carton | piezas/cartón | Mindestbestellmenge | minimum order size | commande minimum | pedido mínimo = 1 Stück | pieces | unités | piezas



Uni-Design	1 m	2,7 m	Erhöhungsblock height adjustment block cale de réhausse bloque de elevación	
Stainless steel matt	48100414	48100402	48100502	
Stainless stell polishes	48100415	48100403	48100503	
Sand	48100412	48100400	48100502	
Silver	48100413	48100401	48100503	

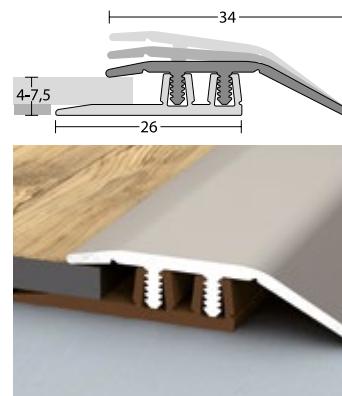





Anpassungsprofil Profi-Design | Adjustment profile Profi-Design | Profilés d'adaptation Profi-Design | Perfil de adaptación Profi-Design

für Belagstärken von 4–7,5 mm, Breite 34 mm | for floor covering thicknesses of 4–7,5 mm, width 34 mm | pour des épaisseurs de revêtement de 4 à 7,5 mm, largeur 34 mm | para grosos de revestimiento de 4–7,5 mm, ancho 34 mm

Zweiteiliges Aluminiumprofil für Übergänge zwischen unterschiedlich hohen Bodenbelägen | Two-part aluminium profile for transitions between floor coverings of different heights | Profilé aluminium en deux parties pour des transitions entre revêtements de hauteurs différentes | Perfil de aluminio de dos partes para pasos entre revestimientos con alturas diferentes

Box = 10 Stück/Karton | pieces/box | unités/carton | piezas/cartón | Mindestbestellmenge | minimum order size | commande minimum | pedido mínimo = 1 Stück | pieces | unités | piezas

Uni-Design	1 m	2,7 m	
Stainless steel brushed	48100496	48100481	
Stainless steel matt	48100494	48100479	
Stainless steel polishes	48100495	48100480	
Sand	48100492	48100477	
Silver	48100493	48100478	

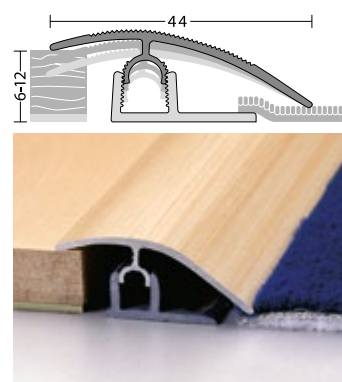







Anpassungsprofil Profitec Junior | Adjustment profile Profitec Junior | Profilés d'adaptation Profitec Junior | Perfil de adaptación Profitec Junior

für Belagstärken von 6–12 mm, Breite 44 mm | for floor covering thicknesses of 6–12 mm, width 44 mm | pour des épaisseurs de revêtement de 6 à 12 mm, largeur 44 mm | para grosos de revestimiento de 6–12 mm, ancho 44 mm

Zweiteiliges Aluminiumprofil für Übergänge zwischen unterschiedlich hohen Bodenbelägen | Two-part aluminium profile for transitions between floor coverings of different heights/ Profilé aluminium en deux parties pour des transitions entre revêtements de hauteurs différentes/ Perfil de aluminio de dos partes para pasos entre revestimientos con alturas diferentes

Box = 10 Stück/Karton | pieces/box | unités/carton | piezas/cartón | Mindestbestellmenge | minimum order size | commande minimum | pedido mínimo = 1 Stück | pieces | unités | piezas

Design	1 m	2,7 m	
Maple		48100437	
Beech		48100435	
Stainless steel matt	48100458	48100434	
Oak light		48100436	
Cherry		48100438	
Nutwood		48100439	
Sand	48100456	48100432	
Silver	48100457	48100433	

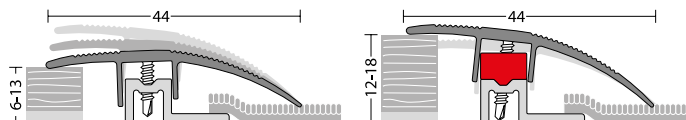

Anpassungsprofil PS400PEP | Adjustment profile PS400PEP | Profils d'adaptation PS400PEP | Perfil de adaptación PS400PEP

für Belagstärken von 6–13 mm, Breite 44 mm | for floor covering thicknesses of 6–13 mm, width 44 mm | pour des épaisseurs de revêtement de 6 à 13 mm, largeur 44 mm | para grosos de revestimiento de 6–13, ancho 44 mm

Geschraubtes, zweiteiliges Aluminiumprofil für Übergänge zwischen unterschiedlich hohen Bodenbelägen | Bolted two-part aluminium profile for covering of different heights | Profile aluminium vissé en deux parties pour des transitions entre revêtements de hauteurs différentes | Perfil de aluminio reapretado de dos partes para pasos entre revestimientos con alturas diferentes

Box = 10 Stück/Karton | pieces/box | unités/carton | piezas/cartón | Mindestbestellmenge | minimum order size commande minimum | pedido mínimo = 1 Stück | pieces | unités | piezas



Uni-Design	1 m	2,7 m	Erhöhungsblock height adjustment block cale de réhausse bloque de elevación
Stainless steel matt	48100418	48100406	48100502
Stainless steel polishes	48100419	48100407	48100503
Sand	48100416	48100404	48100502
Silver	48100417	48100405	48100503

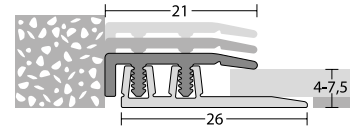





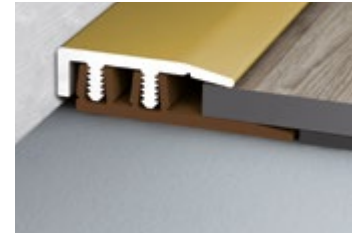

Abschlussprofil Profi-Design | End profile Profi-Design | Profilé de finition Profi-Design | Perfil de acabado Profi-Design

für Belagstärken von 4–7,5 mm, Breite 21 mm | for floor covering thicknesses of 4-7,5 mm, width 21 mm | pour des épaisseurs de revêtement de 4 à 7,5 mm, largeur 21 mm | para grosos de revestimiento de 4–7,5 mm, ancho 21 mm

Zweiteiliges Aluminiumprofil, z. B. für Wandabschlüsse | Two-part aluminium profile for wall endings | Profilé aluminium en deux parties, par ex. pour finitions murales | Perfil de aluminio de dos partes, por ejemplo para acabados de pared

Box = 10 Stück/Karton | pieces/box | unités/carton | piezas/cartón | Mindestbestellmenge | minimum order size | commande minimum | pedido mínimo = 1 Stück | pieces | unités | piezas



Uni-Design	1 m	2,7 m	
Stainless steel brushed	48100501	48100486	
Stainless steel matt	48100499	48100484	
Stainless steel polishes	48100500	48100485	
Sand	48100497	48100482	
Silver	48100498	48100483	

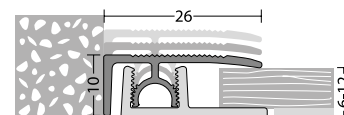

Abschlussprofil Profitec Junior | End profile Profitec Junior | Profilé de finition Profitec Junior | Perfil de acabado Profitec Junior

für Belagstärken von 6–12 mm, Breite 26 mm | for floor covering thicknesses of 6–12mm, width 26 mm | pour des épaisseurs de revêtement de 6 à 12 mm, largeur 26 mm | para grosos de revestimiento de 6–12 mm, ancho 26 mm

Zweiteiliges Aluminiumprofil, z. B. für Wandabschlüsse | Two-part aluminium profile for wall endings | Profilé aluminium en deux parties, par ex. pour finitions murales | Perfil de aluminio de dos partes, por ejemplo para acabados de pared

Box = 10 Stück/Karton | pieces/box | unités/carton | piezas/cartón | Mindestbestellmenge | minimum order size | commande minimum | pedido mínimo = 1 Stück | pieces | unités | piezas



Design	1 m	2,7 m	
Maple	48100469	48100445	
Beech	48100467	48100443	
Stainless steel matt	48100466	48100442	
Light Oak	48100468	48100444	
Cherry	48100470	48100446	
Nutwood	48100471	48100447	
Sand	48100464	48100440	
Silver	48100465	48100441	

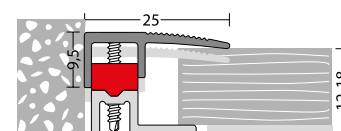
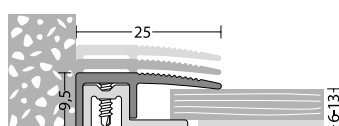

Abschlussprofil PS400PEP | End profile PS400PEP | Profilé de finition PS400PEP | Perfil de acabado PS400PEP

für Belagstärken von 6–13 mm, Breite 25 mm | for floor covering thicknesses of 6–13mm, width 25 mm | pour des épaisseurs de revêtement de 6 à 13 mm, largeur 25 mm | para grosos de revestimiento de 6–13 mm, ancho 25 mm

Geschraubtes, zweiteiliges Aluminiumprofil, z.B. für Wandabschlüsse | Bolted two-part aluminium profile for transitions between floor coverings of different heights | Profilé aluminium visse en deux parties par ex. pour finitions murales de hauteurs différentes | Perfil de aluminio reapretado de dos partes para pasos entre revestimientos con alturas diferentes

Box = 10 Stück/Karton | pieces/box | unités/carton | piezas/cartón | Mindestbestellmenge | minimum order size | commande minimum | pedido mínimo = 1 Stück | pieces | unités | piezas



Uni-Design	1 m	2,7 m	Erhöhungsblock height adjustment block cale de réhausse bloque de elevación	
Stainless steel matt	48100422	48100410	48100502	
Stainless steel polishes	48100423	48100411	48100503	
Sand	48100420	48100408	48100502	
Silver	48100421	48100409	48100503	

VERLEGEUTENSILIEN & REPARATURARTIKEL
 INSTALLATION TOOLS AND REPAIR PRODUCTS
 USTENSILES DE POSE ET DE RÉPARATION
 UTENSILIOS DE INSTALACIÓN Y ARTÍCULOS DE
 REPARACIÓN



Gummihammer | Rubber hammer | Marteau en caoutchouc | Martillo de goma

Art. no. 20021004



Blue Marlin Messer | Blue Marlin knife | Couteau Blue Marlin | Cutter Blue Marlin

Art. no. 20021003



Montagehilfe | Assembly aid | Aide de montage | Ayuda para le montaje

Art. no. 10030652



Rundschnur | Round cord | Cordon rond | Cable redondo

Art. no. 20080300

Ca. 6 mm Ø, 10 m Länge, Einlage für Dehnungsfugen, zur Abdichtung mit Acrylmasse | Approx. 6 mm thick foam round cord with a length of 10 m, used as an insert for expansion joints, for professional sealing with acrylic compound | Cordon rond en mousse de 6 mm s' épaisseur et 10 m de long, pour remplissage des joints de dilatation, pour une mise en oeuvre dans les règles de l'art avec une mastique acrylique | Cable redondo de espuma de aprox. 6 mm de grosor y 10 m de longitud como base para juntas de dilatación para asegurar un cierre profesional con masa de acrílico



Reparatur-Set Hartwachs farbig | Repair set hard wax coloured | Set de réparation cire dure colorée | Set de reparación de cera dura coloreada

Art. no. 10040058

20 Hartwachsstangen à 4 cm Länge in verschiedenen Farben, untereinander mischbar | 20 hard wax sticks, 4 cm length, in various colours, can be mixed with each other | 20 barres de cire dure de 4 cm de longueur dans différents coloris, peuvent être mélangées ensemble | 20 barras de cera dura de 4 cm de largo de diferentes colores, mezclables entre sí



Reparatur-Set Hartwachs transparent | Repair set hard wax transparent | Set de réparation cire dure transparente | Set de reparación de cera dura transparente

Art. no. 10040062

Je 3 Stangen Hart- und Weichwachs à 4 cm Länge inkl. 2 Stangen Füllfix à 8 cm | 3 sticks each of hard and soft wax, 4 cm length, incl. 3 sticks of filler (8 cm) | 3 bâtonnets de cire dure de 4 Cms, 3 bâtonnets de cire molle de 4 Cms, 2 bâtonnets de remplissage de 8 Cms | Cada 3 barras de cera dura y blanda, 4 cm largo y 2 barras material de relleno, 8 cm



Profi Gaslötter | Professional gas solderer | Fer à souder au gaz professionnel | Soldador de gas profesional

Art. no. 10040101

Professioneller Gaslötter zur Erwärmung und Verarbeitung von Hartwachs | Professional gas solderer for heating up and processing hard wax | Fer à souder au gaz professionnel pour chauffer et travailler la cire dure | Soldador de gas profesional para calentar y procesar la cera dura



Füllstoffhobel | Filler plane | Rabot pour cire de réparation | Cepillo de material de relleno

Art. no. 10040061

Zum Abhobeln von Füllstoffen, mattieren oder polieren von Wachsüberständen | For proper fine down of fillers, to matt or polish excess wax | Pour le traitement des cires de rebouchage, pour le rabotage, le matage ou le polissage des excédents de cire | Para procesar de forma limpia los materiales de relleno, rebajar, matear o pulir los resaltes de cera

windmüller flooring products WFP GmbH

Nord-West-Ring 21

D-32832 Augustdorf

Tel.: +49 (0) 52 37 609 - 0

Fax: +49 (0) 52 37 609 - 309

info@wineo.de

www.wineo.de

wineo